

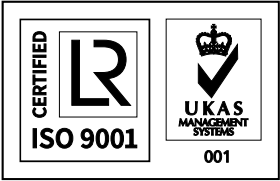

# YN-COUPPLINGS



# APPROVALS



LRQA ISO 9001



WORLD CLASS



(DNV)



(ABS)



(NK)



(LR)



(RMRS)



(BV)



(KR)



# YN-COUPLINGS

Model 11 : FPC-GR-S



Model 1 : GR-S



Model 2 : GR-L



Model 3 : MF-RS



Model 4 : MF-RL



Model 5 : RCH-S



Model 6 : RCH-L



Model 7 : RCD-S



Model 8 : RCD-L



Model 9 : RCH-E



Model 10 : RCD-E



Model 12 : EGR-S



Model 13 : ERCH-S



# YN-COUPLINGS

## NAME OF PARTS

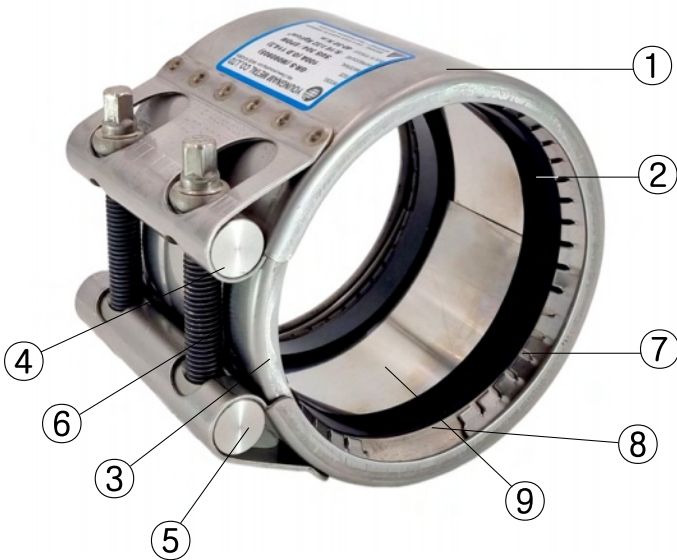

No	Component	Material	
1	Case	SUS 304 / SUS 316L	
2	RUBBER Gasket	EPDM	Water, air, powder, transfer tube, etc. (-30°C ~ +100°C)
		NBR	Various types of oil and gas transfer tube, etc. (-20°C ~ +80°C)
		SILICONE (ND 15A~200A)	High-temperature steam transfer tube, etc. (-50°C ~ +190°C)
		VITON (ND 15A~150A)	For high-temperature chemical transfer tube, etc. (-30°C ~ 220°C)
3	Slide Plate	SUS 304 / SUS 316L	
4	Round Bar Washer	SUS 304 / SUS 316L	
5	Round Bar Nut	SUS 304 / SUS 316L	
6	Bolt	SUS 304 / SUS 316L	
7	Grip Ring	SUS 304 / SUS 301	
8	Grip Insert	SUS 304	
9	Insert-Plate	PE, SUS 304(Option)	

※ Recommended to using the Insert-Plate when the temperatures of over 40°C or Vacuum line. (GR Type, MF Type)



## ECO YN-COUPLINGS

### NAME OF PARTS

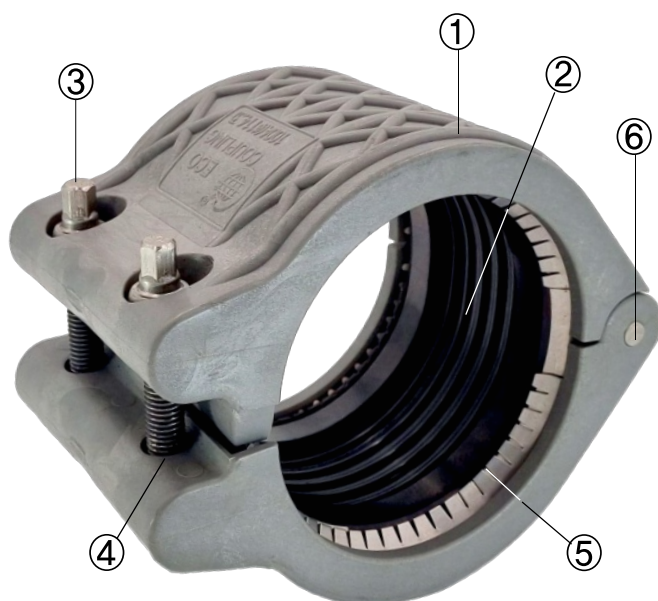

No	Component		Material
1	CASE		Nylon + Fiberglass 30%
2	RUBBER Gasket	EPDM	Water, air, powder, transfer tube, etc. (-30°C ~ +100°C)
		NBR	Various types of oil and gas transfer tube, etc. (-20°C ~ +80°C)
3	BOLT		SUS 304 / SUS 316L
4	NUT		SUS 304
5	GRIP RING		SUS 304
6	HINGE PIN		SUS 304 / SUS 316L

※ Recommended to using the Insert-Plate when the temperatures of over 40°C or Vacuum line. (GR Type, MF Type)

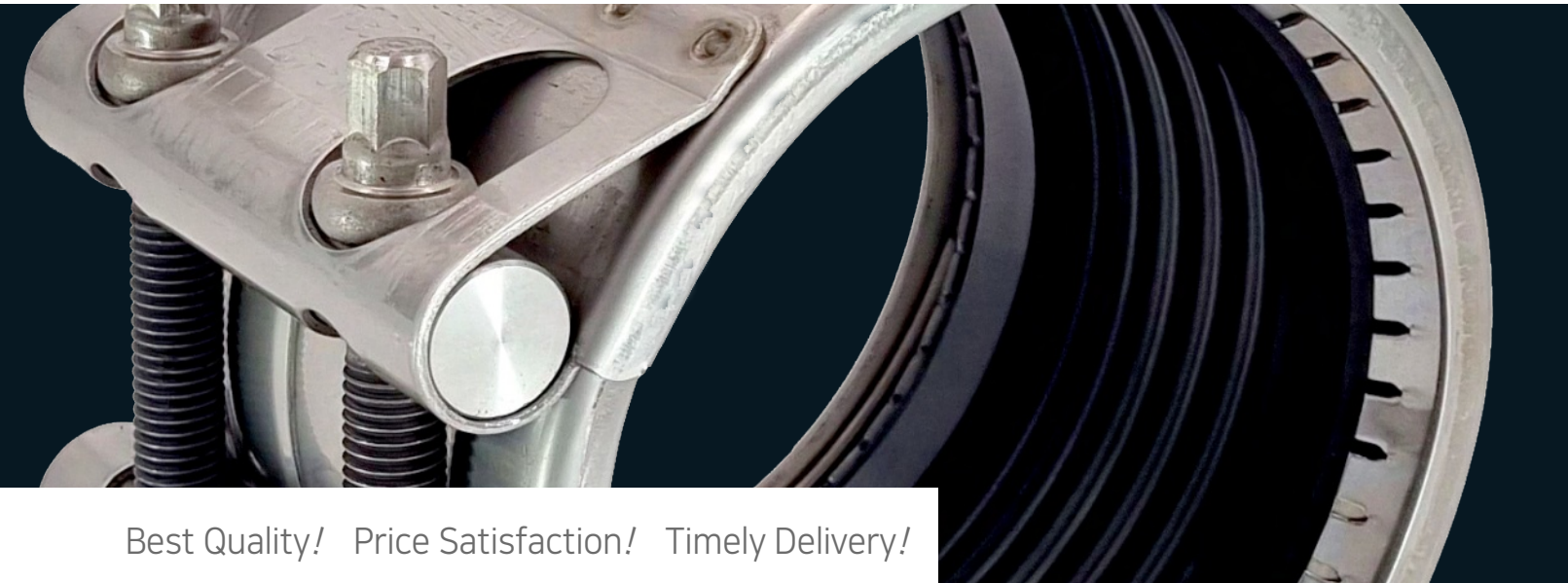

Best Quality! Price Satisfaction! Timely Delivery!



MODEL 1 : GR-S

Grip Type Coupling : GR-S, GR-L :  
Pipe connector with axial restraint

The YOUNGNAM GRIP-Couplings join plain end pipes with axial restraint. YOUNGNAM GRIP coupling provide pull out resistance in excess of the couplings rated working pressure.

Whether for pressure or suction lines, thick or thin wall pipe, the YN-GRIP-Couplings are installed quickly, safely and economically.

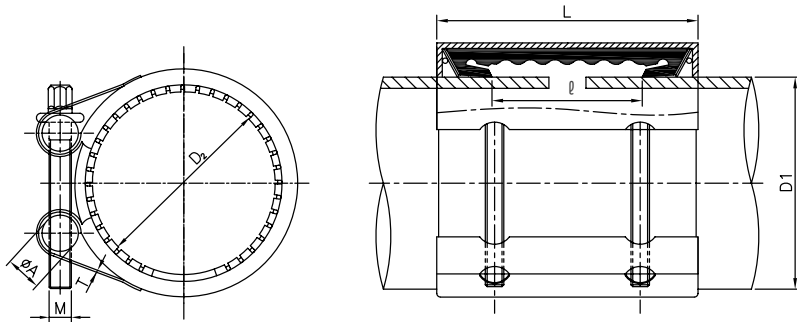



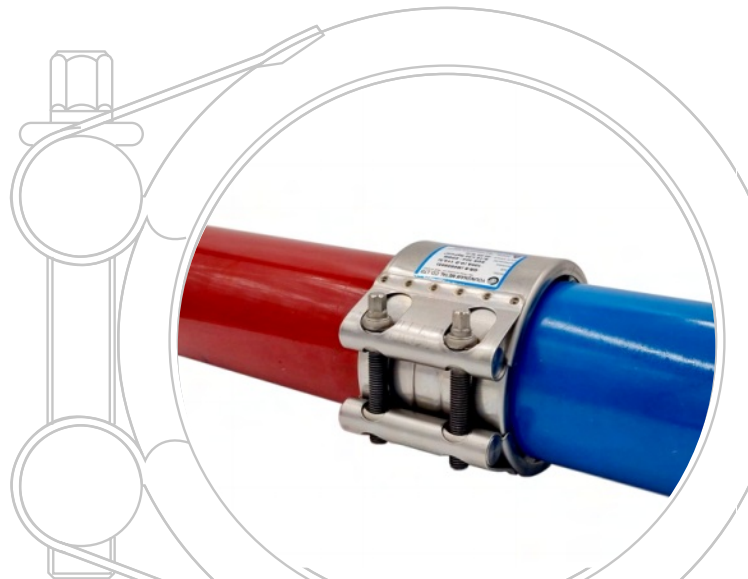

MODEL 2 : GR-L







# GRIP TYPE YN-COUPPLINGS

GR-S									
Size	O.D (mm)	Range (mm)	M	L	ℓ	W.P		W.T	P (N.m(kgf.cm))
ND (Inch)	D1	D2							
15A(1/2")	21.3 / 21.7	O/D±0.3	M6	57	20	40	20	0.18	3~5 (30~50)
20A (3/4")	26.0 / 26.9 / 26.7 / 27.2	O/D ±0.5	M6	57	20	40	20	0.21	4~6 (40~60)
25A (1")	30.0 / 32.0 / 33.4 / 33.7 / 34.0	O/D ±0.6	M6	57	20	40	20	0.23	4~6 (40~60)
32A (1-1/4")	38.0 / 40.9 / 42.2 / 42.4 / 42.7	O/D ±0.6	M8	57	20	40	20	0.34	10~12 (100~120)
40A (1-1/2")	44.5 / 48.3 / 48.6 / 50.8	O/D ±1.0	M8	57	22	40	20	0.36	10~12 (100~120)
50A (2")	54.0 / 57.0 / 60.3 / 60.5 / 63.0	O/D ±1.0	M10	80	30	36	18	0.80	15~18 (150~180)
65A (2-1/2")	66.7 / 69.0 / 73.0 / 76.3	O/D ±1.0	M10	80	30	36	18	0.89	15~18 (150~180)
80A (3")	79.8 / 84.0 / 88.9 / 89.1	O/D ±1.5	M12	108	50	32	16	1.56	40~50 (400~500)
90A (3-1/2")	101.6	O/D ±1.5	M12	108	50	32	16	1.64	40~50 (400~500)
100A (4")	104.8 / 106.3 / 108.0 / 114.3	O/D ±1.5	M12	108	50	32	16	1.77	40~50 (400~500)
125A (5")	129.0 / 133.0 / 139.8 / 141.3	O/D ±1.5	M14	117	55	28	12	2.95	60~80 (600~800)
150A (6")	154.0 / 159.0 / 165.2 / 168.3	O/D ±1.5	M14	117	55	28	12	3.15	60~80 (600~800)
200A (8")	204.0 / 216.3 / 219.1	O/D ±2.0	M16	155	72	24	7	6.60	120~150 (1200~1500)
250A (10")	254.0 / 267.4 / 273.1	O/D ±2.0	M16	155	65	20	7	7.55	120~150 (1200~1500)
300A (12")	304.0 / 318.5 / 323.9 / 325.0	O/D ±2.0	M18	155	65	14	5	9.75	170~190 (1700~1900)
350A (14")	355.6	O/D ±2.0	M18	155	65	14	5	10.58	170~190 (1700~1900)

GR-L									
Size	O.D (mm)	Range (mm)	M	L	ℓ	W.P		W.T	P (N.m(kgf.cm))
ND (Inch)	D1	D2							
15A(1/2")	21.3 / 21.7	O/D±0.3	M6	72	40	40	20	0.23	3~5 (30~50)
20A (3/4")	26.9 / 26.7 / 27.2	O/D ±0.5	M6	72	40	40	20	0.26	4~6 (40~60)
25A (1")	33.4 / 33.7 / 34.0	O/D ±0.6	M8	100	55	40	20	0.46	5~8 (50~80)
32A (1-1/4")	42.2 / 42.4 / 42.7	O/D ±0.6	M8	100	55	40	20	0.53	10~12 (100~120)
40A (1-1/2")	48.3 / 48.6	O/D ±1.0	M8	100	55	40	20	0.57	10~12 (100~120)
50A (2")	60.3 / 60.5	O/D ±1.0	M10	139	84	36	18	1.29	15~18 (150~180)
65A (2-1/2")	76.3	O/D ±1.0	M10	139	84	36	18	1.43	15~18 (150~180)
80A (3")	88.9 / 89.1	O/D ±1.5	M12	203	122	32	16	2.83	40~50 (400~500)
90A (3-1/2")	98.0	O/D ±1.5	M12	203	122	32	16	3.00	40~50 (400~500)
100A (4")	114.3 / 118.0	O/D ±1.5	M12	203	122	32	16	3.18	40~50 (400~500)
125A (5")	139.8 / 141.3	O/D ±1.5	M14	204	128	28	12	4.80	60~80 (600~800)
150A (6")	159.0 / 165.2 / 168.3	O/D ±1.5	M14	204	128	28	12	5.24	60~80 (600~800)
200A (8")	216.3 / 219.1	O/D ±2.0	M16	255	157	24	7	10.74	120~150 (1200~1500)
250A (10")	267.4 / 273.1	O/D ±2.0	M16	255	157	20	7	12.08	120~150 (1200~1500)
300A (12")	318.5 / 323.9 / 325.0	O/D ±2.0	M18	255	157	14	5	15.60	170~190 (1700~1900)

ND : Nominal Diameter (A)  
 D1 : Actual Outer Diameter of Pipe (mm)  
 D2 : Min./Max. Allowable Limit for Pipe (mm)  
 M : Fastener Bolt Size  
 L : Coupling Width (mm)

ℓ : Allowable Shrinkage/Expansion Clearance (mm)  
 (Maximum Pipe Gap = 50% of "ℓ" with Insert Plate.)  
 W.P : Working Pressure (Kgf/cm<sup>2</sup>) : Industrial() , Ship()  
 W/T : Weight Per Unit (kg)  
 P : Optimum Locking Torque Value (Nm (kgf·cm))

※ The specifications are subject to change for quality improvement.



Best Quality! Price Satisfaction! Timely Delivery!



Multi-Flex Type Coupling : MF-RS, MF-RL :  
Pipe connector with non axial restraint.

The YN-Multi Flex type coupling will join virtually any plain end pipe.  
Expansion and contraction movement as well as angular deflection.

MODEL 3 : MF-RS

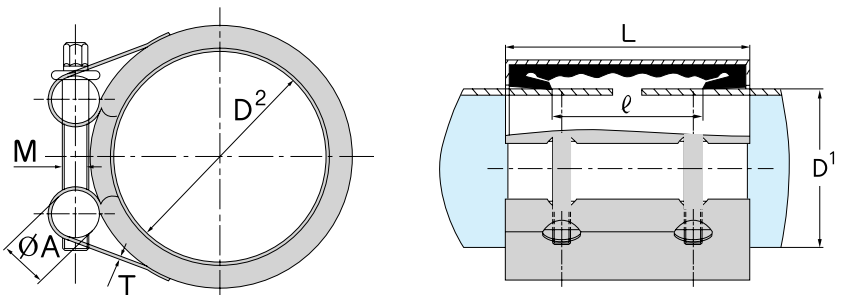

MODEL 4 : MF-RL

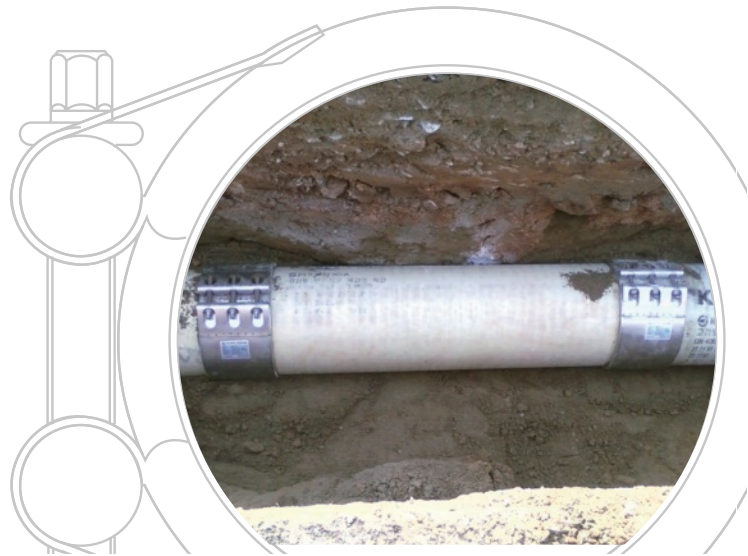





# MULTI-FLEX TYPE YN-COUPPLINGS

## MF-RS

Size ND (Inch)	O.D (mm) D1	Range (mm) D2	M	L	ℓ	W.P		W.T	P (N.m(kgf.cm))
15A (1/2")	15.9 / 21.3 / 21.7	0/D±0.3	M6	57	34	40	20	0.17	3~5 (30~50)
20A (3/4")	25.0 / 26.9 / 26.7 / 27.2	0/D ±0.5	M6	57	32	40	20	0.19	3~5 (30~50)
25A (1")	31.8 / 33.4 / 33.7 / 34.0	0/D ±0.6	M6	57	32	40	20	0.21	3~5 (30~50)
32A (1-1/4")	38 / 40.9 / 42.2 / 42.4 / 42.7	0/D ±0.6	M8	57	32	40	20	0.30	5~8 (50~80)
40A (1-1/2")	50.8 / 44.5 / 48.3 / 48.6	0/D ±1.0	M8	57	32	40	20	0.32	5~8 (50~80)
50A (2")	54.0 / 57.0 / 60.3 / 60.5	0/D ±1.0	M10	80	46	36	18	0.72	10~12 (100~120)
65A (2-1/2")	66.7 / 69.0 / 73.0 / 76.3	0/D ±1.0	M10	80	46	36	18	0.79	10~12 (100~120)
80A (3")	79.8 / 84.0 / 88.9 / 89.1	0/D ±1.5	M12	107	65	32	16	1.41	20~30 (200~300)
90A (3-1/2")	101.6	0/D ±1.5	M12	107	65	32	16	1.52	20~30 (200~300)
100A (4")	104.8 / 108.0 / 114.3 / 118.0	0/D ±1.5	M12	107	65	32	16	1.58	20~30 (200~300)
125A (5")	129.0 / 133.0 / 139.8 / 141.3	0/D ±1.5	M14	117	71	28	14	2.59	40~50 (400~500)
150A (6")	154.0 / 159.0 / 165.2 / 168.3	0/D ±1.5	M14	117	71	28	14	2.84	40~50 (400~500)
200A (8")	204.0 / 216.3 / 219.1 / 225	0/D ±2.0	M16	155	80	24	10	6.25	60~80 (600~800)
250A (10")	241.8 / 254.0 / 267.4 / 273.1 / 280	0/D ±2.0	M16	155	80	24	10	7.01	60~80 (600~800)
300A (12")	318.5 / 323.9 / 325.0	0/D ±2.0	M18	155	80	20	8	9.21	80~120 (800~1200)
350A (14")	355.6~	0/D ±2.0	M18	155	80	20	8	9.92	80~120 (800~1200)
400A (16")	406.4~	0/D ±2.5	M18	155	94	16	5	10.70	80~120 (800~1200)
450A (18")	457.2~	0/D ±2.5	M18	155	94	16	5	11.76	80~120 (800~1200)
500A (20")	508.0~	0/D ±3.0	M18	155	94	14	4	12.60	120~150 (1200~1500)

## MF-RL

Size ND (Inch)	O.D (mm) D1	Range (mm) D2	M	L	ℓ	W.P		W.T	P (N.m(kgf.cm))
15A (1/2")	21.3 / 21.7	0/D±0.3	M6	72	46	40	20	0.22	3~5 (30~50)
20A (3/4")	26.9 / 26.7 / 27.2	0/D ±0.5	M6	72	46	40	20	0.25	3~5 (30~50)
25A (1")	33.4 / 33.7 / 34.0	0/D ±0.6	M8	100	70	40	20	0.44	4~6 (40~60)
32A (1-1/4")	42.2 / 42.4 / 42.7	0/D ±0.6	M8	100	64	40	20	0.52	5~8 (50~80)
40A (1-1/2")	48.3 / 48.6	0/D ±1.0	M8	100	64	40	20	0.54	5~8 (50~80)
50A (2")	57.0 / 60.3 / 60.5	0/D ±1.0	M10	139	99	36	18	1.22	10~12 (100~120)
65A (2-1/2")	73.0 / 76.3	0/D ±1.0	M10	139	99	36	18	1.34	10~12 (100~120)
80A (3")	88.9 / 89.1	0/D ±1.5	M12	203	146	32	16	2.68	20~30 (200~300)
90A (3-1/2")	98.0	0/D ±1.5	M12	203	146	32	16	2.83	20~30 (200~300)
100A (4")	108.0 / 114.3 / 118.0	0/D ±1.5	M12	203	146	32	16	3.03	20~30 (200~300)
125A (5")	133.0 / 139.8 / 141.3	0/D ±1.5	M14	204	138	28	14	4.56	40~50 (400~500)
150A (6")	159.0 / 165.2 / 168.3	0/D ±1.5	M14	204	138	28	14	4.98	40~50 (400~500)
200A (8")	216.3 / 217.0 / 219.1	0/D ±2.0	M16	255	177	24	10	10.29	60~80 (600~800)
250A (10")	267.4 / 273.1	0/D ±2.0	M16	255	177	24	10	11.50	60~80 (600~800)
300A (12")	318.5 / 323.9 / 325.0	0/D ±2.0	M18	255	177	20	8	15.00	80~120 (800~1200)
350A (14")	355.6~	0/D ±2.0	M18	255	170	20	8	16.62	80~120 (800~1200)
400A (16")	406.4~	0/D ±2.5	M18	255	170	16	5	18.08	80~120 (800~1200)
450A (18")	457.2~	0/D ±2.5	M18	255	170	16	5	19.33	80~120 (800~1200)
500A (20")	508.0~	0/D ±3.0	M18	255	170	14	4	21.15	120~150 (1200~1500)

ND : Nominal Diameter (A)

D1 : Actual Outer Diameter of Pipe (mm)

D2 : Min./Max. Allowable Limit for Pipe (mm)

M : Fastener Bolt Size

L : Coupling Width (mm)

ℓ : Allowable Shrinkage/Expansion Clearance (mm)

(Maximum Pipe Gap = 50% of "ℓ" with Insert Plate.)

W.P : Working Pressure (Kgf/cm) : Industrial () , Ship ()

W/T : Weight Per Unit (kg)

P : Optimum Locking Torque Value (Nm (kgf·cm))

※ The specifications are subject to change for quality improvement.

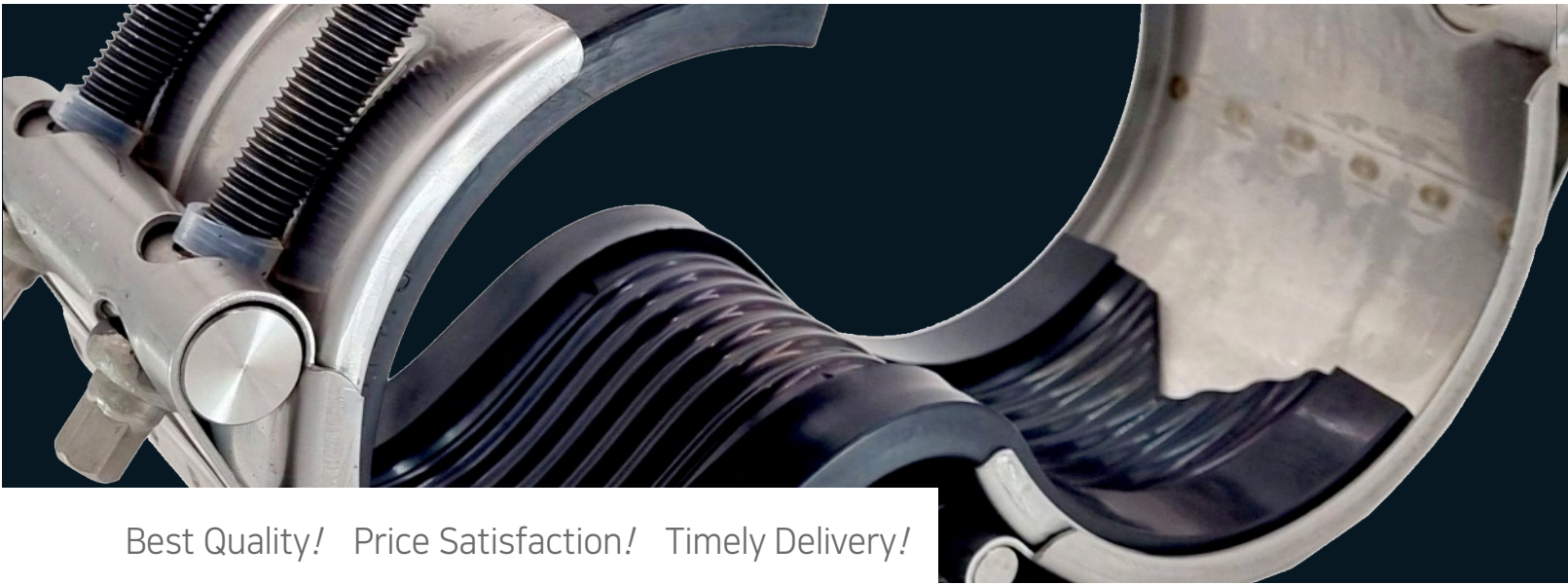

Best Quality! Price Satisfaction! Timely Delivery!



MODEL 5 : RCH-S

### Repair Clamp Hinge Type Coupling : RCH-S, RCH-L

The YN-REPAIR HINGE Clamp is a split in half coupling and open split version of Multi Flex, offering all the YOUNGNAM REPAIR HINGE benefits, plus being able to make repairs to in service pipe lines.

With the YOUNGNAM REPAIR HINGE coupling, leaks due to faulty weld joints, pitting holes and short cracks can be temporarily or permanently repaired with minimal down time.

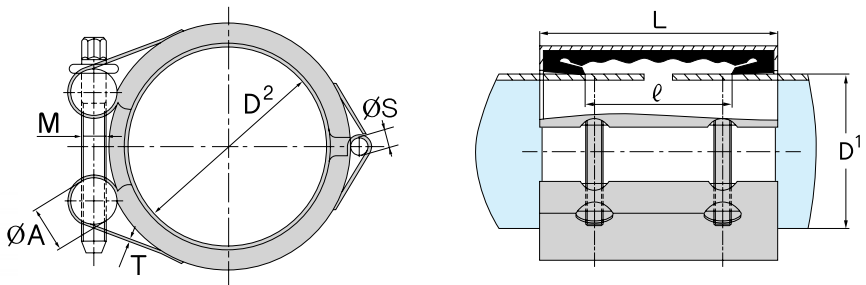

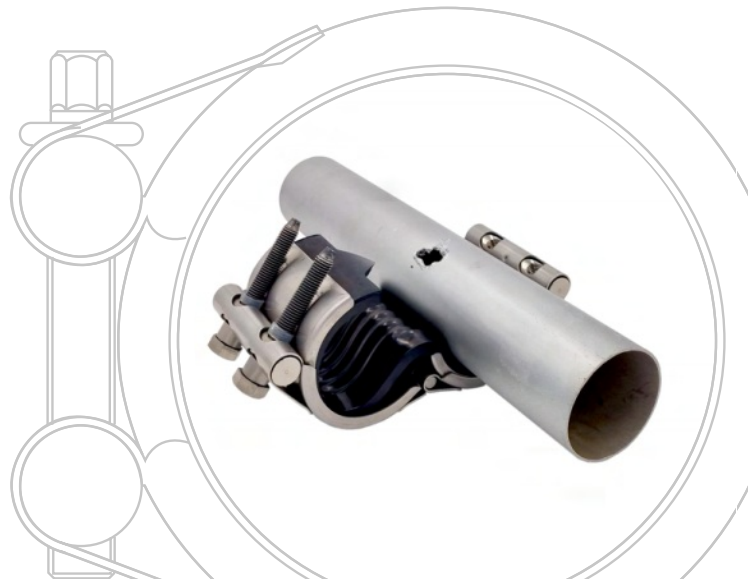

MODEL 6 : RCH-L









# HINGE TYPE YN-COUPPLINGS

**RCH-S** ※ PIPE O.D. specs are available for all sizes.

Size ND (Inch)	O.D (mm) D1	Range (mm) D2	M	L	ℓ	W.P		W.T	P (N.m(kgf.cm))
									
15A (1/2")	15.9 / 21.3 / 21.7	O/D±0.3	M6	57	34	28	14	0.20	3~5 (30~50)
20A (3/4")	25.0 / 26.7 / 26.9 / 27.2	O/D ±0.5	M6	57	32	28	14	0.23	3~5 (30~50)
25A (1")	31.8 / 33.4 / 33.7 / 34.0	O/D ±0.6	M6	57	32	28	14	0.25	3~5 (30~50)
32A (1-1/4")	38 / 40.9 / 42.2 / 42.4 / 42.7	O/D ±0.6	M8	57	32	24	12	0.36	4~6 (40~60)
40A (1-1/2")	50.8 / 44.5 / 48.3 / 48.6	O/D ±1.0	M8	57	32	24	12	0.37	4~6 (40~60)
50A (2")	54.0 / 57.0 / 60.3 / 60.5	O/D ±1.0	M10	80	46	20	10	0.81	8~10 (80~100)
65A (2-1/2")	66.7 / 69.0 / 73.0 / 76.3	O/D ±1.0	M10	80	46	20	10	0.88	8~10 (80~100)
80A (3")	79.8 / 84.0 / 88.9 / 89.1	O/D ±1.5	M12	107	65	16	8	1.63	20~25 (200~250)
90A (3-1/2")	98.0 / 101.6	O/D ±1.5	M12	107	65	16	8	1.71	20~25 (200~250)
100A (4")	104.8 / 108.0 / 114.3 / 118.0	O/D ±1.5	M12	107	65	16	8	1.80	20~25 (200~250)
125A (5")	129.0 / 133.0 / 139.8 / 141.3	O/D ±1.5	M14	117	71	16	8	2.96	30~35 (300~350)
150A (6")	154.0 / 159.0 / 165.2 / 168.3	O/D ±1.5	M14	117	71	16	8	3.20	30~35 (300~350)
200A (8")	204.0 / 216.3 / 219.1 / 225	O/D ±2.0	M16	155	80	14	7	6.94	40~50 (400~500)
250A (10")	241.8 / 254.0 / 267.4 / 273.1 / 280	O/D ±2.0	M16	155	80	14	7	7.67	40~50 (400~500)
300A (12")	315.0 / 318.5 / 323.9 / 325.0	O/D ±2.0	M18	155	80	12	6	10.01	60~80 (600~800)
350A (14")	355.6 ~	O/D ±2.0	M18	155	80	12	6	10.68	60~80 (600~800)
400A (16")	400.0 ~	O/D ±2.5	M18	155	94	10	4	11.70	80~100 (800~1000)
450A (18")	457.2 ~	O/D ±2.5	M18	155	94	10	4	12.55	80~100 (800~1000)
500A (20")	508.0 ~	O/D ±3.0	M18	155	94	10	3	13.45	100~120 (1000~1200)

**RCH-L** ※ PIPE O.D. specs are available for all sizes.

Size ND (Inch)	O.D (mm) D1	Range (mm) D2	M	L	ℓ	W.P		W.T	P (N.m(kgf.cm))
									
15A (1/2")	21.3 / 21.7	O/D±0.3	M6	72	46	28	14	0.25	3~5 (30~50)
20A (3/4")	26.9 / 26.7 / 27.2	O/D ±0.5	M6	72	46	28	14	0.30	3~5 (30~50)
25A (1")	33.4 / 33.7 / 34.0	O/D ±0.6	M8	100	70	28	14	0.52	3~5 (30~50)
32A (1-1/4")	42.2 / 42.4 / 42.7	O/D ±0.6	M8	100	64	24	12	0.61	4~6 (40~60)
40A (1-1/2")	48.3 / 48.6	O/D ±1.0	M8	100	64	24	12	0.62	4~6 (40~60)
50A (2")	57.0 / 60.3 / 60.5	O/D ±1.0	M10	139	99	20	10	1.40	8~10 (80~100)
65A (2-1/2")	73.0 / 76.3	O/D ±1.0	M10	139	99	20	10	1.51	8~10 (80~100)
80A (3")	88.9 / 89.1	O/D ±1.5	M12	203	146	16	8	3.07	20~25 (200~250)
90A (3-1/2")	98.0 / 101.6	O/D ±1.5	M12	203	146	16	8	3.25	20~25 (200~250)
100A (4")	108.0 / 114.3 / 118.0	O/D ±1.5	M12	203	146	16	8	3.35	20~25 (200~250)
125A (5")	133.0 / 139.8 / 141.3	O/D ±1.5	M14	204	138	16	8	5.19	30~35 (300~350)
150A (6")	159.0 / 165.2 / 168.3	O/D ±1.5	M14	204	138	16	8	5.60	30~35 (300~350)
200A (8")	216.3 / 219.1	O/D ±2.0	M16	255	177	14	7	11.55	40~50 (400~500)
250A (10")	267.4 / 273.1	O/D ±2.0	M16	255	177	14	7	12.78	40~50 (400~500)
300A (12")	318.5 / 323.9 / 325.0	O/D ±2.0	M18	255	177	12	6	16.51	60~80 (600~800)
350A (14")	355.6 ~	O/D ±2.0	M18	255	170	12	6	18.18	60~80 (600~800)
400A (16")	400.0 ~	O/D ±2.5	M18	255	170	10	4	19.80	80~100 (800~1000)
450A (18")	457.2 ~	O/D ±2.5	M18	255	170	10	4	21.22	80~100 (800~1000)
500A (20")	508.0 ~	O/D ±3.0	M18	255	170	10	3	22.68	100~120 (1000~1200)

ND : Nominal Diameter (A)  
 D1 : Actual Outer Diameter of Pipe (mm)  
 D2 : Min./Max. Allowable Limit for Pipe (mm)  
 M : Fastener Bolt Size  
 L : Coupling Width (mm)  
 ℓ : Allowable Shrinkage/Expansion Clearance (mm)  
 W.P : Working Pressure (Kgf/cm<sup>2</sup>) : Industrial() , Ship()  
 W/T : Weight Per Unit (kg)  
 P : Optimum Locking Torque Value (Nm (kgf·cm))

※ The specifications are subject to change for quality improvement.

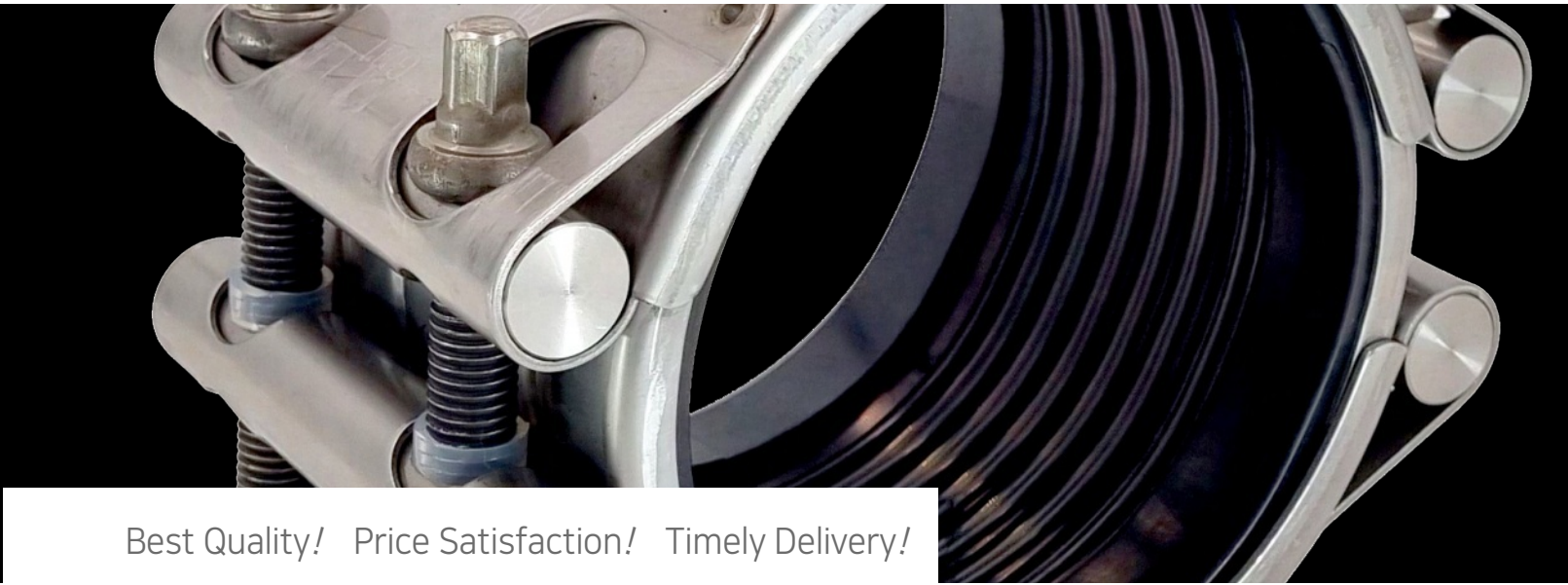

Best Quality! Price Satisfaction! Timely Delivery!



MODEL 7 : RCD-S

### Repair or Connect Clamp Double Type Coupling : RCD-S, RCD-L

The YN-RCD type is a open split version of repair or connect pipe clamp, plus being able to make repairs and connect to in service pipe lines.

leaks due to faulty weld joints, pitting holes and short cracks can be temporarily or permanently repaired with minimal down time. The split gasket design can be wrapped around the pipe and installed without pipe disassembly.

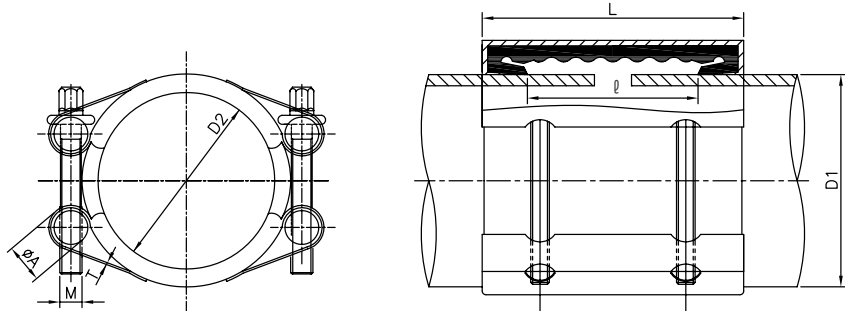

MODEL 8 : RCD-L

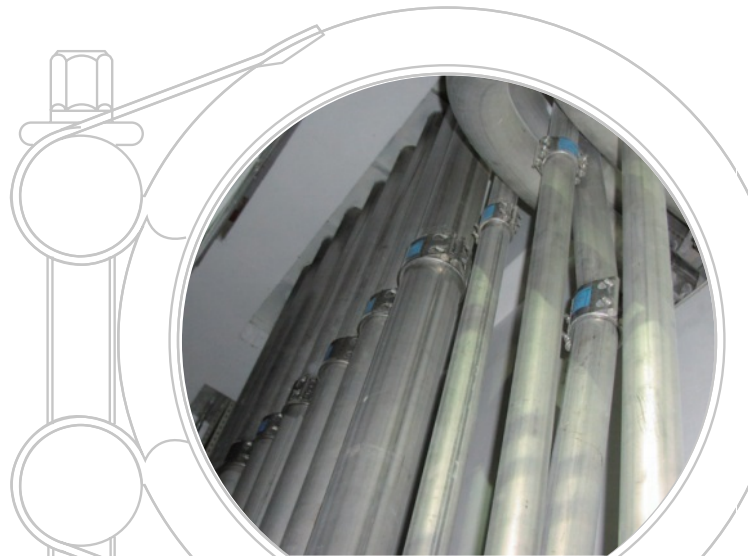

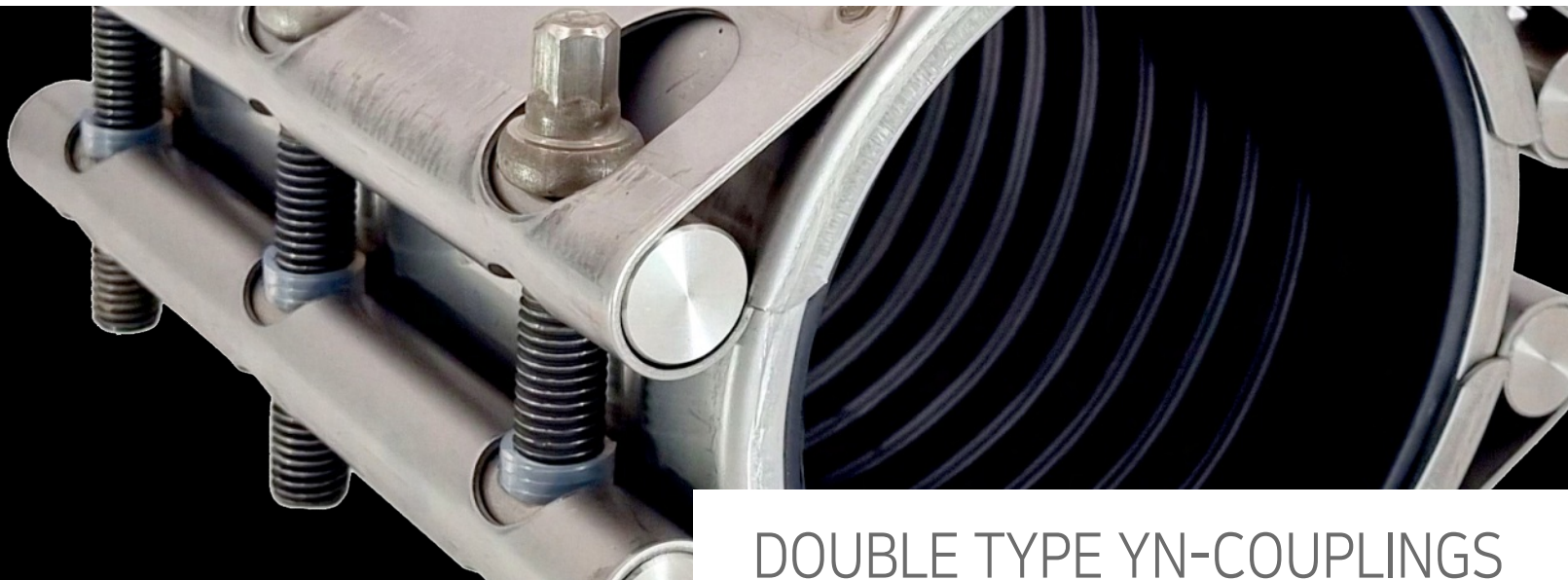

## DOUBLE TYPE YN-COUPPLINGS

### RCD-S (20A~3,000A) Available

※ PIPE O.D. specs are available for all sizes.

Size	O.D (mm)	Range (mm)	M	L	ℓ	W.P	W.T	P (N.m(kgf.cm))
ND (Inch)	D1	D2						
20A (3/4")	25.0 / 26.7 / 26.9 / 27.2	O/D ±0.5	M6	57	32	28	0.30	3~5 (30~50)
25A (1")	31.8 / 33.4 / 33.7 / 34.0	O/D ±0.6	M6	57	32	28	0.32	3~5 (30~50)
32A (1-1/4")	38 / 40.9 / 42.2 / 42.4 / 42.7	O/D ±0.6	M8	57	32	24	0.47	5~10 (50~100)
40A (1-1/2")	50.8 / 44.5 / 48.3 / 48.6	O/D ±1.0	M8	57	32	24	0.48	5~10 (50~100)
50A (2")	54.0 / 57.0 / 60.3 / 60.5	O/D ±1.0	M10	80	46	20	1.10	10~15 (100~150)
65A (2-1/2")	66.7 / 69.0 / 73.0 / 76.3	O/D ±1.0	M10	80	46	20	1.17	10~15 (100~150)
80A (3")	79.8 / 84.0 / 88.9 / 89.1	O/D ±1.5	M12	107	65	16	2.10	20~30 (200~300)
90A (3-1/2")	98.0 / 101.6	O/D ±1.5	M12	107	65	16	2.22	20~30 (200~300)
100A (4")	104.8 / 108.0 / 114.3 / 118.0	O/D ±1.5	M12	107	65	16	2.29	20~30 (200~300)
125A (5")	129.0 / 133.0 / 139.8 / 141.3	O/D ±1.5	M14	117	71	16	3.79	40~50 (400~500)
150A (6")	154.0 / 159.0 / 165.2 / 168.3	O/D ±1.5	M14	117	71	16	4.09	40~50 (400~500)
200A (8")	204.0 / 216.3 / 219.1 / 225	O/D ±2.0	M16	155	80	14	8.85	60~80 (600~800)
250A (10")	241.8 / 254.0 / 267.4 / 273.1 / 280	O/D ±2.0	M16	155	80	14	9.63	60~80 (600~800)
300A (12")	315.0 / 318.5 / 323.9 / 325.0	O/D ±2.0	M18	155	80	12	12.36	80~120 (800~1200)
350A (14")	355.6 ~	O/D ±2.0	M18	155	80	12	12.96	80~120 (800~1200)
400A (16")	400.0 ~	O/D ±2.5	M18	155	94	10	13.81	80~120 (800~1200)
450A (18")	457.2 ~	O/D ±2.5	M18	155	94	10	14.76	80~120 (800~1200)
500A (20")	500.0 ~	O/D ±3.0	M18	155	94	10	15.60	120~150 (1200~1500)

### RCD-L (20A~3,000A) Available

※ PIPE O.D. specs are available for all sizes.

Size	O.D (mm)	Range (mm)	M	L	ℓ	W.P	W.T	P (N.m(kgf.cm))
ND (Inch)	D1	D2						
20A (3/4")	26.9 / 26.7 / 27.2	O/D ±0.5	M6	72	46	28	0.37	3~5 (30~50)
25A (1")	33.4 / 33.7 / 34.0	O/D ±0.6	M8	100	70	28	0.70	3~5 (30~50)
32A (1-1/4")	42.2 / 42.4 / 42.7	O/D ±0.6	M8	100	64	24	0.80	5~10 (50~100)
40A (1-1/2")	48.3 / 48.6	O/D ±1.0	M8	100	64	24	0.82	5~10 (50~100)
50A (2")	57.0 / 60.3 / 60.5	O/D ±1.0	M10	139	99	20	1.90	10~15 (100~150)
65A (2-1/2")	73.0 / 76.3	O/D ±1.0	M10	139	99	20	2.02	10~15 (100~150)
80A (3")	88.9 / 89.1	O/D ±1.5	M12	203	146	16	3.94	20~30 (200~300)
90A (3-1/2")	98.0 / 101.6	O/D ±1.5	M12	203	146	16	4.17	20~30 (200~300)
100A (4")	108.0 / 114.3 / 118.0	O/D ±1.5	M12	203	146	16	4.35	20~30 (200~300)
125A (5")	133.0 / 139.8 / 141.3	O/D ±1.5	M14	204	138	16	6.40	40~50 (400~500)
150A (6")	159.0 / 165.2 / 168.3	O/D ±1.5	M14	204	138	16	6.90	40~50 (400~500)
200A (8")	216.3 / 219.1	O/D ±2.0	M16	255	177	14	14.88	60~80 (600~800)
250A (10")	267.4 / 273.1	O/D ±2.0	M16	255	177	14	16.04	60~80 (600~800)
300A (12")	318.5 / 323.9 / 325.0	O/D ±2.0	M18	255	177	12	20.36	80~120 (800~1200)
350A (14")	355.6 ~	O/D ±2.0	M18	255	170	12	21.84	80~120 (800~1200)
400A (16")	400.0 ~	O/D ±2.5	M18	255	170	10	23.56	80~120 (800~1200)
450A (18")	457.2 ~	O/D ±2.5	M18	255	170	10	24.98	80~120 (800~1200)
500A (20")	500.0 ~	O/D ±3.0	M18	255	170	10	26.48	120~150 (1200~1500)

ND : Nominal Diameter (A)

D1 : Actual Outer Diameter of Pipe (mm)

D2 : Min./Max. Allowable Limit for Pipe (mm)

M : Fastener Bolt Size

L : Coupling Width (mm)

ℓ : Allowable Shrinkage/Expansion Clearance (mm)

(Maximum Pipe Gap = 50% of "ℓ" with Insert Plate.)

W.P : Working Pressure (Kgf/cm<sup>2</sup>)

W/T : Weight Per Unit (kg)

P : Optimum Locking Torque Value (Nm (kgf.cm))

※ The specifications are subject to change for quality improvement.

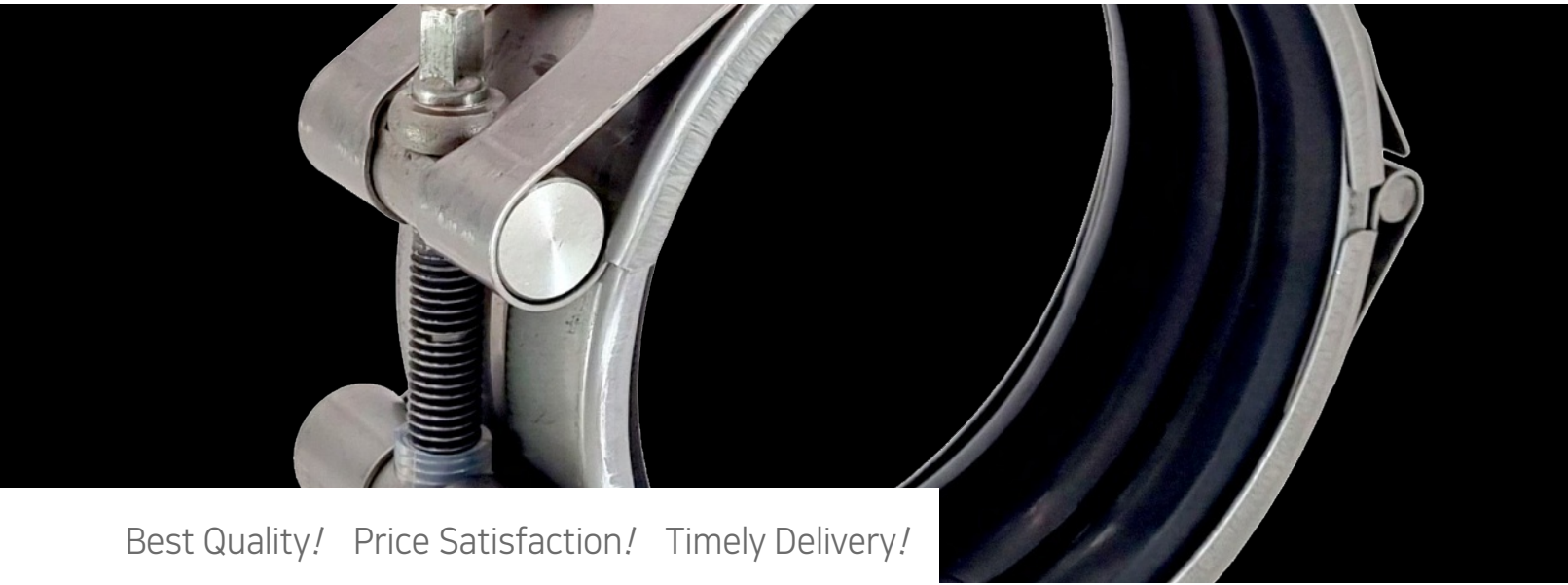

Best Quality! Price Satisfaction! Timely Delivery!



MODEL 9 : RCH-E

### Elbow (Cross and Tee)-Repair Clamp Type Coupling : RCH-E, RCD-E

The YN-ELBOW REPAIR Clamp type is a split in half coupling and open split version, plus being able to make repairs to in service Elbow(Cross and Tee) pipe lines.

With the REPAIR HINGE and OPEN SPLIT coupling, leaks due to faulty weld joints, pitting holes and short cracks can be temporarily or permanently repaired with minimal down time.



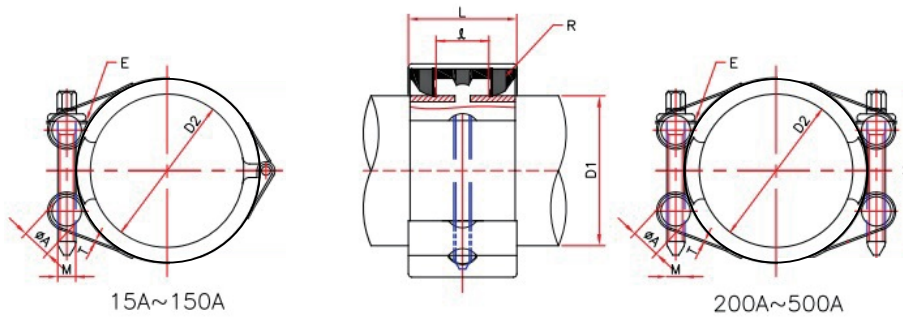

MODEL 10 : RCD-E







# ELBOW REPAIR TYPE YN-COUPPLINGS

## RCH-E

Size ND (Inch)	O.D (mm) D1	Range (mm) D2	M	L	ℓ	W.P		W.T	P (N.m(kgf.cm))
									
15A (1/2")	21.7 / 21.3	O/D ± 0.3	M6	26.3	12.5	22	11	0.092	3~5(30~50)
20A (3/4")	27.2 / 26.7	O/D ± 0.5	M6	26.3	12.5	18	8	0.098	3~5(30~50)
25A (1")	34 / 33.4	O/D ± 0.6	M6	26.3	12.5	18	8	0.10	3~5(30~50)
32A (1-1/4")	42.7 / 42.2	O/D ± 0.6	M6	26.3	12.5	18	8	0.11	3~5(30~50)
40A (1-1/4")	48.6 / 48.3	O/D ± 1.0	M6	26.3	12.5	18	8	0.12	3~5(30~50)
50A (2")	60.5 / 60.3	O/D ± 1.0	M8	41.8	19.5	16	7	0.30	12~15(120~150)
65A (2-1/2")	76.3 / 73	O/D ± 1.0	M8	41.8	19.5	16	7	0.32	12~15(120~150)
80A (3")	89.1 / 88.9	O/D ± 1.0	M10	52.4	28	14	7	0.60	20~25(200~250)
100A (4")	114.3	O/D ± 1.0	M10	52.4	28	14	7	0.67	20~25(200~250)
125A (5")	139.8 / 141.3	O/D ± 1.0	M12	52.4	28	14	7	0.85	30~32(300~320)
150A (6")	165.2 / 168.3	O/D ± 1.0	M12	52.4	28	14	7	0.88	30~32(300~320)

## RCD-E

※ PIPE O.D. specs are available for all sizes.

Size ND (Inch)	O.D (mm) D1	Range (mm) D2	M	L	ℓ	W.P		W.T	P (N.m(kgf.cm))
									
200A (8")	204.0 / 216.3 / 219.1 / 225	O/D ± 2.0	M12	57.5	30	12	6	1.65	32~35(320~350)
250A (10")	254.0 / 267.4 / 273.1 / 280	O/D ± 2.0	M12	57.5	30	12	6	1.84	32~35(320~350)
300A (12")	318.5 / 323.9 / 325.0	O/D ± 2.0	M14	58.5	30	10	5	2.67	45~50(450~500)
350A (14")	355.6~	O/D ± 2.0	M14	58.5	30	10	5	2.81	45~50(450~500)
400A (16")	400.0~	O/D ± 2.0	M14	58.5	30	10	5	3.02	55~60(550~600)
450A (18")	457.2~	O/D ± 2.0	M14	58.5	30	8	4	3.25	55~60(550~600)
500A (20")	500.0~	O/D ± 2.0	M14	58.5	30	7	3	3.53	65~70(650~700)

ND : Nominal Diameter (A)



D1 : Actual Outer Diameter of Pipe (mm)

D2 : Min./Max. Allowable Limit for Pipe (mm)

M : Fastener Bolt Size

L : Coupling Width (mm)

ℓ : Allowable Shrinkage/Expansion Clearance (mm)

W.P : Working Pressure (Kgf/cm<sup>2</sup>) : Industrial() , Ship()

W/T: Weight Per Unit (kg)

P : Optimum Locking Torque Value (Nm (kgf·cm))

※ The specifications are subject to change for quality improvement.



Best Quality! Price Satisfaction! Timely Delivery!



MODEL 11 : FPC-GR-S

### Fire Protect Cover Grip Type Coupling : FPC-GR-S

Fire Protection Cover Grip Ring pipe couplings FPC GR-S (DN15-DN350) withstand fire better than regular couplings. Couplings suitable to be used with metal pipes and Suitable for engine room application on ships.

1. Axially restrained pipe coupling, no pull out or vibration
2. Fire Testing according to ISO 19921 & 19922 regulation 30 minutes at 800°C
3. Maintains internal structure of the coupling during a fire
4. SS304 or SS316L Stainless Steel Couplings with EPDM, NBR, Silicone and VITON.

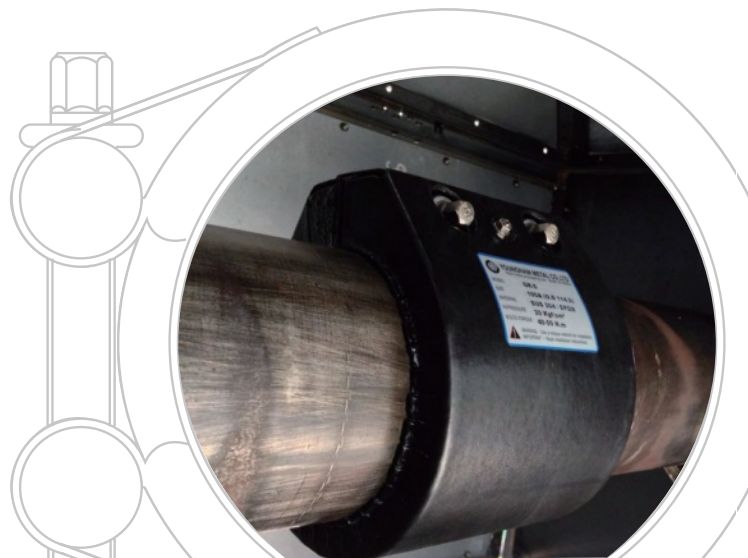
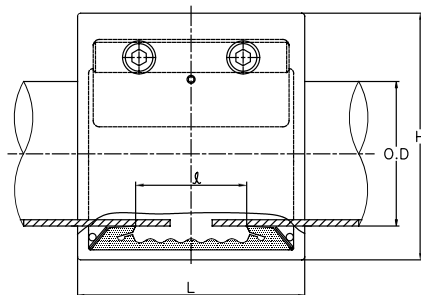
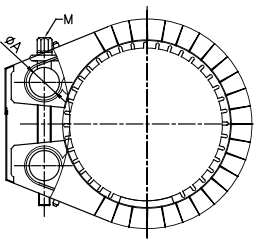





# FIREPROOF YN-COUPPLINGS

## FPC-GR-S

Size	O.D (mm)		Range (mm)	M	L	ℓ	H	W.P	W.T	P (N.m(kgf.cm))
	ND (Inch)	D1						D2		
15A (1/2")		21.3 / 21.7	O/D ±0.3	M6	68	20	40	20	0.28	3~5 (30~50)
20A (3/4")		25.0 / 26.9 / 26.7 / 27.2	O/D ±0.5	M6	68	20	63	20	0.32	4~6 (40~60)
25A (1")		30.0 / 32.0 / 33.4 / 33.7 / 34.0	O/D ±0.6	M6	68	20	70	20	0.35	4~6 (40~60)
32A (1-1/4")		38.0 / 40.9 / 42.2 / 42.4 / 42.7	O/D ±0.6	M8	68	20	81	20	0.45	10~12 (100~120)
40A (1-1/2")		44.5 / 48.3 / 48.6 / 50.8	O/D ±1.0	M8	68	22	87	20	0.5	10~12 (100~120)
50A (2")		54.0 / 57.0 / 60.3 / 60.5 / 63.0	O/D ±1.0	M10	94	30	109	18	1.0	15~18 (150~180)
65A (2-1/2")		66.7 / 69.0 / 73.0 / 76.3	O/D ±1.0	M10	94	30	124	18	1.2	15~18 (150~180)
80A (3")		79.8 / 84.0 / 88.9 / 89.1	O/D ±1.5	M12	122	50	144	16	2.1	40~50 (400~500)
90A (3"-1/2")		101.6	O/D ±1.5	M12	122	50	171	16	2.4	40~50 (400~500)
100A (4")		104.8 / 106.3 / 108.0 / 114.3	O/D ±1.5	M12	122	50	171	16	2.4	40~50 (400~500)
125A (5")		129.0 / 133.0 / 139.8 / 141.3	O/D ±1.5	M14	138	55	203	12	3.8	60~80 (600~800)
150A (6")		154.0 / 159.0 / 165.2 / 168.3	O/D ±1.5	M14	138	55	229	12	4.2	60~80 (600~800)
200A (8")		204.0 / 216.3 / 219.1	O/D ±2.0	M16	176	72	297	7	11.2	120~150 (1200~1500)
250A (10")		254.0 / 267.4 / 273.1	O/D ±2.0	M16	176	65	348	7	12.9	120~150 (1200~1500)
300A (12")		304.0 / 318.5 / 323.9 / 325.0	O/D ±2.0	M18	176	65	400	5	14.9	170~190 (1700~1900)
350A (14")		355.6	O/D ±2.0	M18	176	65	439	5	16.1	170~190 (1700~1900)

ND : Nominal Diameter (A)

D1 : Actual Outer Diameter of Pipe (mm)

D2 : Min./Max. Allowable Limit for Pipe (mm)



M : Fastener Bolt Size

L : Fireproof Cover Width (mm)

ℓ : Allowable Shrinkage/Expansion Clearance (mm)

(Maximum Pipe Gap = 50% of "ℓ" with Insert Plate.)

H : Fireproof Cover Height (mm)

W.P : Working Pressure (Kgf/cm<sup>2</sup>) : Industrial() , Ship()

W/T : Weight Per Unit (kg)

P : Optimum Locking Torque Value (Nm (kgf·cm))

※ The specifications are subject to change for quality improvement.

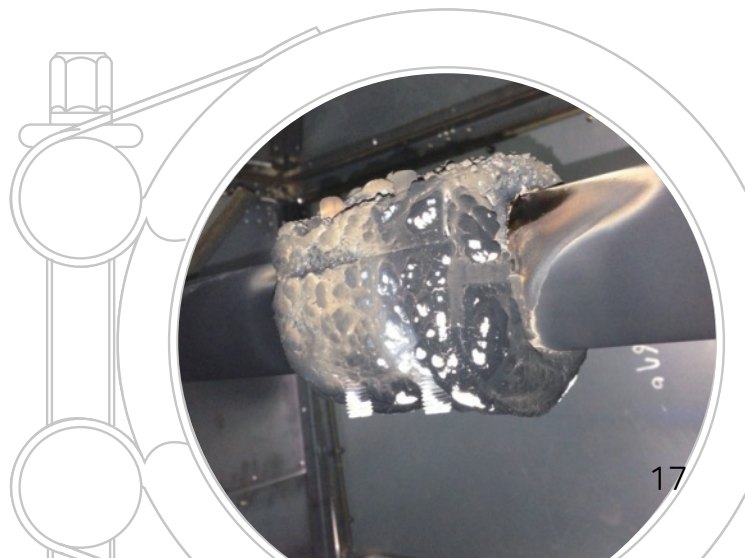

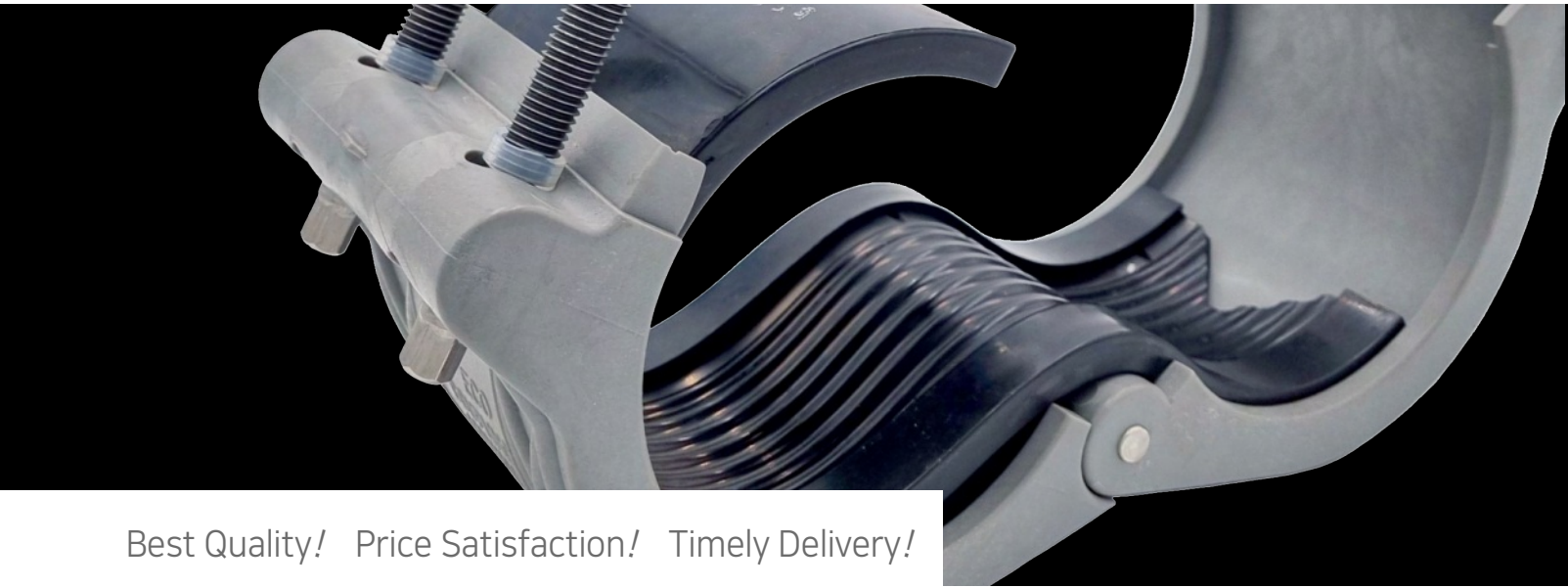

Best Quality! Price Satisfaction! Timely Delivery!



Eco-Grip Type Coupling : EGR-S :  
Pipe connector with axial restraint

MODEL 12 : EGR-S



Eco-Repair Clamp Hinge Type Coupling : ERCH-S

MODEL 13 : ERCH-S

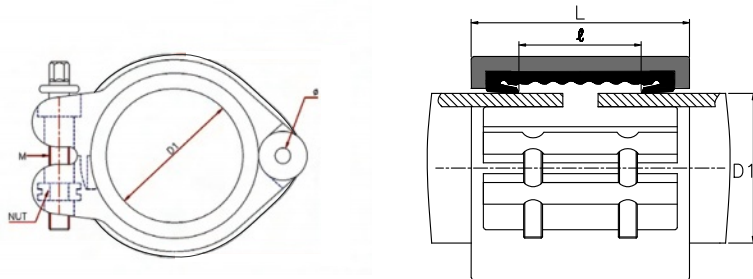

Eco-MultiFlex Type Coupling : EMF-RS :  
Pipe connector with non axial restraint.

MODEL 14 : EMF-RS



# ECO YN-COUPLINGS

## EGR-S

Size	O.D (mm)		M	L	ℓ	W.P	W.T	P (N.m(kgf.cm))
	D1							
20A (3/4")	27.2 / 26.7		M6	63	19	20	0.2	6~8(60~80)
25A (1")	34 / 33.4		M6	63	19	20	0.24	6~8(60~80)
32A (1-1/4")	42.7 / 42.2		M8	64	20	20	0.32	12~14(120~140)
40A (1-1/4")	48.6 / 48.3		M8	64	20	18	0.34	12~14(120~140)
50A (2")	60.5 / 60.3		M10	88	30	15	0.68	15~17(150~170)
65A (2-1/2")	76.3 / 73		M10	88	30	15	0.77	15~17(150~170)
80A (3")	89.1 / 88.9		M12	114	48	13	1.38	20~25(200~250)
100A (4")	114.3		M12	114	48	12	1.56	20~25(200~250)

## ERCH-S

Size	O.D (mm)		M	L	ℓ	W.P	W.T	P (N.m(kgf.cm))
	D1							
15A (1/2")	21.7 / 21.3		M6	63	34	20	0.16	5~6(50~60)
20A (3/4")	27.2 / 26.7		M6	63	30	20	0.18	6~8(60~80)
25A (1")	34 / 33.4		M6	63	30	20	0.2	6~8(60~80)
32A (1-1/4")	42.7 / 42.2		M8	64	30	20	0.3	8~10(80~100)
40A (1-1/4")	48.6 / 48.3		M8	64	30	18	0.32	8~10(80~100)
50A (2")	60.5 / 60.3		M10	88	44	15	0.62	12~14(120~140)
65A (2-1/2")	76.3 / 73		M10	88	44	15	0.7	12~14(120~140)
80A (3")	89.1 / 88.9		M12	114	63	13	1.28	16~18(160~180)
100A (4")	114.3		M12	114	63	12	1.48	16~18(160~180)

## EMF-RS

Size	O.D (mm)		M	L	ℓ	W.P	W.T	P (N.m(kgf.cm))
	D1							
15A (1/2")	21.7 / 21.3		M6	63	34	20	0.16	5~6(50~60)
20A (3/4")	27.2 / 26.7		M6	63	30	20	0.18	6~8(60~80)
25A (1")	34 / 33.4		M6	63	30	20	0.2	6~8(60~80)
32A (1-1/4")	42.7 / 42.2		M8	64	30	20	0.3	8~10(80~100)
40A (1-1/4")	48.6 / 48.3		M8	64	30	18	0.32	8~10(80~100)
50A (2")	60.5 / 60.3		M10	88	44	15	0.62	12~14(120~140)
65A (2-1/2")	76.3 / 73		M10	88	44	15	0.7	12~14(120~140)
80A (3")	89.1 / 88.9		M12	114	63	13	1.28	16~18(160~180)
100A (4")	114.3		M12	114	63	12	1.48	16~18(160~180)

ND : Nominal Diameter (A)  
D1 : Actual Outer Diameter of Pipe (mm)  
M : Fastener Bolt Size  
L : Coupling Width (mm)

ℓ : Allowable Shrinkage/Expansion Clearance (mm)  
(Maximum Pipe Gap = 50% of "ℓ" with Insert Plate.)  
W.P : Working Pressure (Kgf/cm)  
W/T : Weight Per Unit (kg)  
P : Optimum Locking Torque Value (Nm (kgf.cm))

※ The specifications are subject to change for quality improvement.



## YN - COUPLING GUIDE

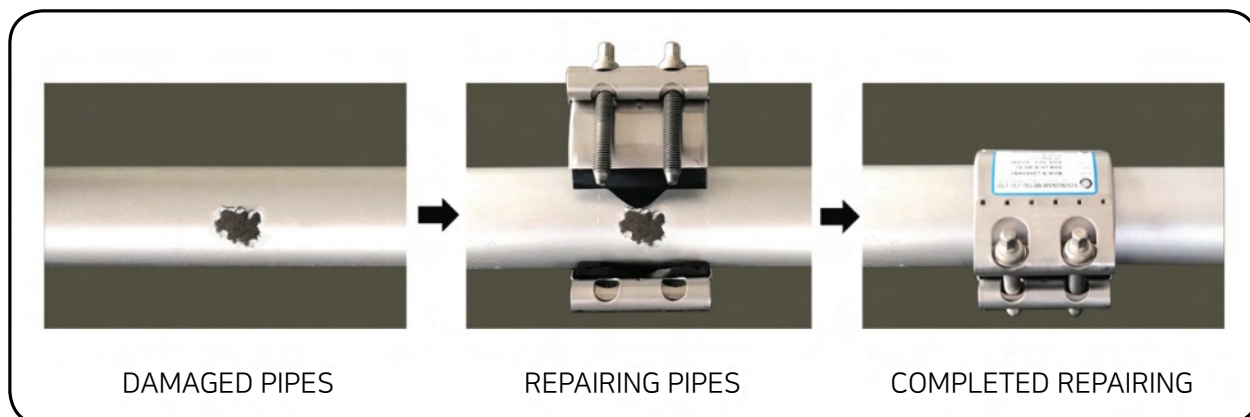
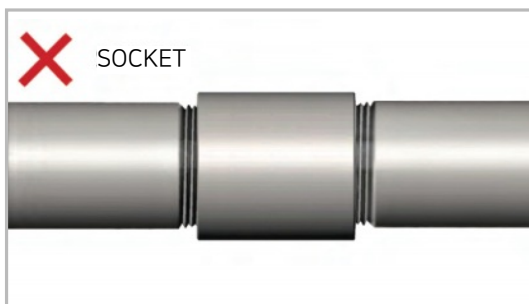
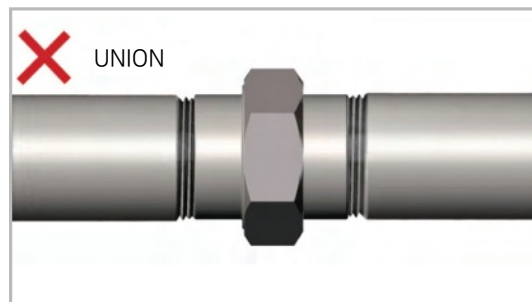

# WIDE LARGE TYPE YN-COUPLINGS



YN-COUPLING  
RCD-L3  
(Width 300mm)  
300A~3,000A



YN-COUPLING  
RCD-L5  
(Width 500mm)  
500A~4,000A



YN-COUPLING  
RCD-L7  
(Width 700mm)  
800A~5,000A

Remark : YN COUPLING Length(mm) (L:300, L:500, L:700 Available by order)



312mm for ocean bed connection



Large size pipe couplings



Installation of ocean bed blocks



Installing prepare

# YN-PIPE COUPLING SITE APPLICATION

## Applications for the shipbuilding industry

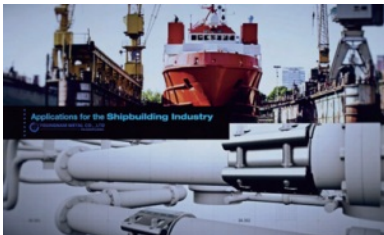

Firefighting lines, plumbing, ballast, sanitary, compressed air, cooling water systems, seawater, fresh water, drains, soundings, electric cable protection, oil transfer, and fuel oil lines, MULTI-FLEX, GRIP RING PIPE COUPLINGS are used in a wide range of applications. They have front and back, left and right torsions in the calibrated part of the center line. For places with a high noise level, they guarantee various useful functions, such as a 30% lighter weight than the general flange connection process. In particular, the long-sized coupling, with its long attachment Length, is an innovative product for the shipbuilding industry, where severe vibration, shrinkage, and expansion commonly occur.

## For Oil supply and piping for district heating works

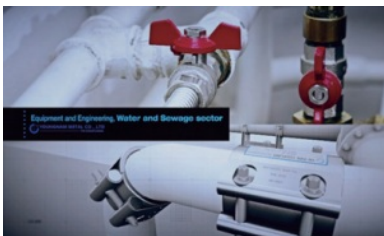

Oil pipes and dual-pipes for heating works are mostly welded; however, such a welding process has its drawbacks: the weld zone requires ultra-precision welding technology, and if a fault about the size of the eye of a needle develops, gas and warm water is sure to continue to leak underground, thereby causing fatigue phenomena, soft ground, and excessive load. We are justly proud that this product is the only solution to prevent a major accident arising from such factors, particularly with respect to pipes buried underground.

## Piping for heavy industry



As it is used annually for repairs to cold and warm water pump lines and LPG, LNG, and GAS pipelines, its cost efficiency has already been proved. In particular, the pipe ends do not need to be machined, but can be used as they are. If there are no severe rock pockets, or rust or rock pockets are minor, its functions remain intact and in perfect condition.

## Piping in mechanical device sectors that experience vibrations



Widely used as intake and discharge piping for clean water, seawater and cooling water, and as pipes for compressed air, powder, chemicals, coal, etc. If the pipe is blocked due to wastewater and intake and discharge is prevented, the coupling can be detached again, cleaned and reassembled, thereby minimizing the hassle, cost, and manpower.

## For industrial plants

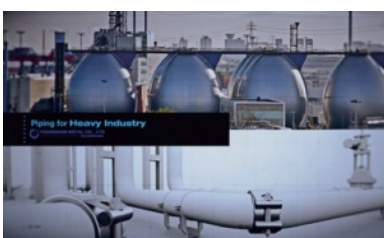

As it reduces stationary vibrations and noise occurring from continuous vibration and from the mechanical parts of a rotating machine or power units by more than 60%, strains on the accessory equipment or gauges are reduced.

## Applied to shipbuilding companies



It is used for connecting PVC pipes with stainless steel pipes made of entirely different materials, and for coupling heterogeneous pipes such as stainless steel pipes and cast iron pipes. Even though a deviation of about  $0^{\circ}\sim 5^{\circ}$  occurs, airtightness is definitely maintained.

# APPLICATION OF PIPE COUPLING

## Applications of the product

- Installed in the indoor and outdoor pipelines of factories, general buildings, and in insulated dual pipe (district heating works).
- Used for installing/repairing new pipes in commercial ships and battleship engines and decks, and for making repair to the pipes of vessels in operation.
- Used to connect water and sewage pipes, drainpipes, firefighting pipes, water supply pipes, agricultural water supply pipes, conduits, hume pipes and PVC, FRP pipes, etc.
- Used for installing water pipe and drainpipes in nuclear, thermal, and hydroelectric power plants.
- Used for installing subway structures and for pipe buried underground and underwater.
- Used for installing oil pipelines in refineries and gas pipes buried underground
- Used for installing equipment pipes, transmission pipes in refrigeration plants, and others.

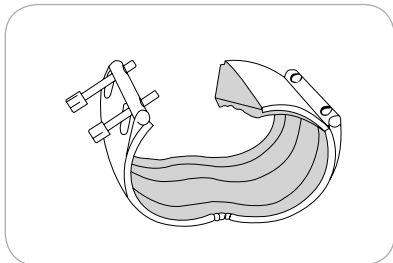

Easy use for repair of indoor and outdoor piping in new or old building

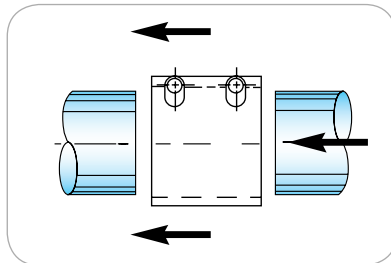

No need for special tools. It has the function of completely absorbing external impacts and vibrations.

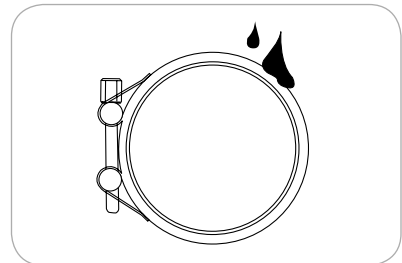

Made of strong corrosion-resistant stainless steel 304, 316L materials, it prevents corrosion even in contact with corrosive waste-water or chemicals from the outside.

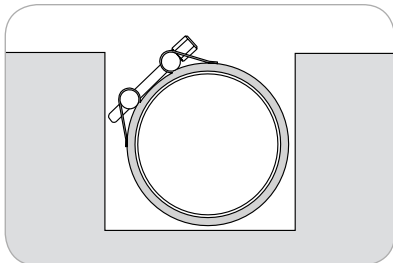

Designed and manufactured by an efficient construction method for use even in confined space, its cost efficiency is guaranteed.

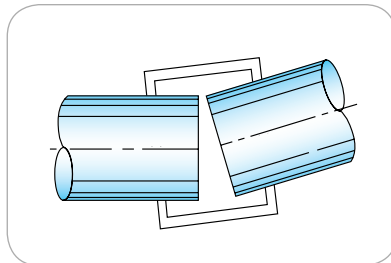

The center torsion is allowed up to 1°~5° on both sides.

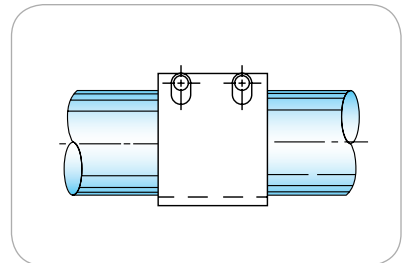

The contents remain airtight even when outside impacts are applied to the front, back, left and right instantaneously or in succession.

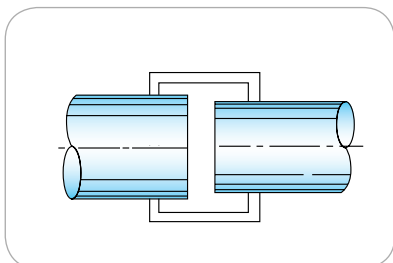

Absolutely no problems occur even if the pipe outer diameter (mm) is either larger or smaller by about 1%.

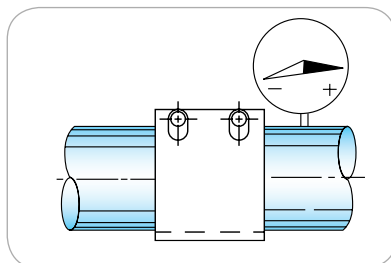

Despite the instantaneous inside pressure inflow or vacuum state, its function remains in perfect condition.

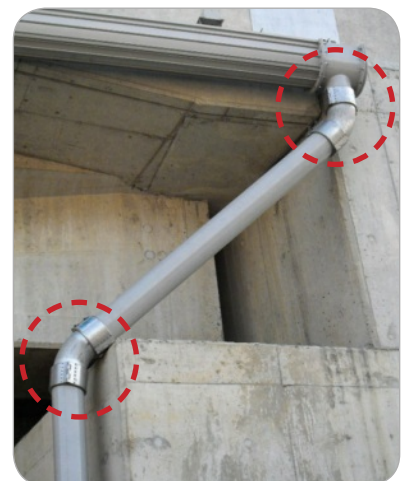

Drainage Line

# TEST SPECIFICATION OF PIPE COUPLING

Test Method : IACS Req. 2001/ Rev.4 2016

Test Item		Type		Test Method												
		Grip	Slip													
1	Tightness Test	Applied	Applied	Connect a mechanical joint in the space between pipe, pressurize it with a pressure 1.5 times the design pressure and maintain it for 5 minutes. PASS if it is leak free.												
2	Vibration Test	Applied	-	<p>Perform the three tests on the pipe connected to a mechanical joint by maintaining design pressure. PASS only if all three tests prove to be leak free.</p> <table border="1"> <thead> <tr> <th>Number of cycle</th> <th>Amplitude, mm</th> <th>Frequency, Hz</th> </tr> </thead> <tbody> <tr> <td>3×10<sup>6</sup></td> <td>±0.06</td> <td>100</td> </tr> <tr> <td>3×10<sup>6</sup></td> <td>±0.5</td> <td>45</td> </tr> <tr> <td>3×10<sup>6</sup></td> <td>±1.5</td> <td>10</td> </tr> </tbody> </table>	Number of cycle	Amplitude, mm	Frequency, Hz	3×10 <sup>6</sup>	±0.06	100	3×10 <sup>6</sup>	±0.5	45	3×10 <sup>6</sup>	±1.5	10
Number of cycle	Amplitude, mm	Frequency, Hz														
3×10 <sup>6</sup>	±0.06	100														
3×10 <sup>6</sup>	±0.5	45														
3×10 <sup>6</sup>	±1.5	10														
3	Pressure Pulsation Test	Applied	-	A test to check whether an assembly with mechanical joints can withstand pressure pulsation. Increase the impact pressure to 1.5 times the design pressure from zero within a frequency range of 30~ 50 cycles per minute, with the number of cycles being over 500,000, and check for any leaks or signs of fault. PASS only if no faults are detected.												
4	Burst Pressure Test	Applied	Applied	A test intended to check whether an assembly that passed a watertight test can withstand a burst pressure four times the design pressure. PASS only if it is leak free even when the foregoing pressure is applied.												
5	Pull-Out Test	Applied	-	<p>When the load pressurized up to the design pressure and calculated by the following equation is applied to an assembly in the direction of axial load to verify that the assembly with a mechanical joint is not separated from the connected pipe under the axial load that can be generated while the assembly is in use. It must be leak free to be declared as PASS.</p> $L = \frac{\pi}{4} \cdot D^2 \cdot P$ <p>(축방향하중) (관의경) (설계압력)</p>												
6	Fire Test	Applied	Applied	Expose an assembly with a mechanical joint to a flame at 800°C for 30 minutes in a state where water is in circulation at over 80 under the design pressure of a joint. (Have the flame envelop the test material.) PASS only if there is no leak.												
7	Vacuum Test	Applied	Applied	Connect the assembly that has a mechanical joint to a vacuum pump to make the pressure 170hPa (absolute pressure). If the pressure is stabilized, separate the vacuum pump from the assembly with a mechanical joint being tested and keep it in this condition for 5 minutes. PASS only if no fault occurs in this state.												
8	Repeated Assembly Test	Applied	-	Combine and separate the test material with a mechanical joint 10 times according to the manufacturer's instructions and carry out the prescribed watertight test. PASS if there is no leak.												



# YN-PIPE COUPLING MANUFACTURING TO SITE



▲ Busan New Port Container Terminal Construction Work



▲ Repair work for pipes replaced underground



▲ 48" (1,200A) MF-RL Canadian power plant cooling line



▲ PE Pipe Repair



▲ Netherland desalination treatment facilities



▲ Spain: water purification facilities



▲ Japan : "T" Repair



▲ Canada: water purification facility

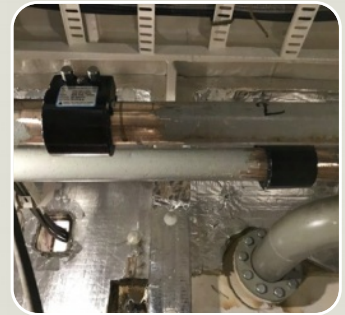

▲ Russia : Ship



▲ U.S.: sewerage repair work

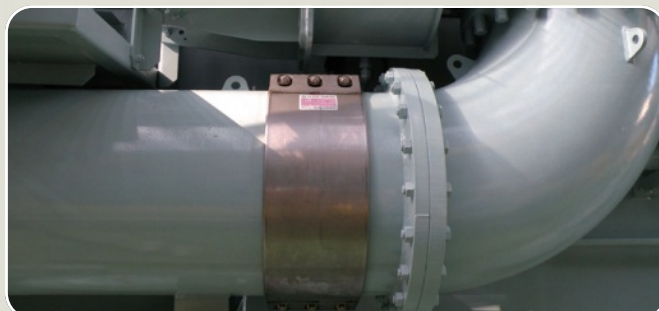

▲ Engine Air Line



▲ PVC + Steel Pipe Connection

# YN-PIPE COUPLING MANUFACTURING TO SITE



▲ Engine Parts



▲ Shipbuilding



▲ Water Works



▲ Industry Plant



▲ Machine



▲ WATERWORKS



# PIPE OUTSIDE DIAMETER COMPARISON

UNIT : mm

Nominal Diameter		KS/JIS	ASTM ANSI	ISO DIN	BS	GRP PIPE	DUCTILE PIPE	COPPER PIPE	SU PIPE	PE PIPE	PVC PIPE	HUME PIPE
15A	1/2"	21.7	21.3	21.3	21.2				22.2	21.5	22.0	
20A	3/4"	27.2	26.7	26.9	26.7			22.2	28.6	27.0	26.0	
25A	1"	34.0	33.4	33.7	34.1			28.6	34.0	34.0	32.0	
32A	1-1/4"	42.7	42.2	42.4	42.8			34.9	42.7	42.0	42.0	
40A	1-1/2"	48.6	48.3	48.3	48.4			41.3	48.6	48.0	48.0	
50A	2"	60.5	60.3	60.3	60.3			54.0	60.5	60.0	60.0	
65A	2-1/2"	76.3	73.0	76.1	76.2			66.7	76.3	76.0	76.0	
80A	3"	89.1	88.9	88.9	89.9		98.0	79.4	89.1	89.0	89.0	
90A	3-1/4"	101.6	101.6	101.6	101.6			92.1				
100A	4"	114.3	114.3	114.3	114.3		118.0	104.8	114.3	114.0	114.0	
125A	5"	139.8	141.3	139.7	159.4		144.0	130.2		140.0	140.0	
150A	6"	165.2	168.3	168.3	165.1	167.0	170.0	155.6		165.0	165.0	
200A	8"	216.3	219.1	219.1	219.1	217.0	222.0	206.4		216.0	216.0	
250A	10"	267.4	273.1	273.0	273.1	267.0	274.0	257.2		267.0	267.0	306.0
300A	12"	318.5	323.9	323.9	323.8	318.0	326.0			318.0	318.0	360.0
350A	14"	355.6	355.6	355.6	355.6	369.0	378.0			370.0		414.0
400A	16"	406.4	406.4	406.4	406.4	419.0	429.0			420.0		470.0
450A	18"	457.2	457.2	457.2	457.2	470.0				457.2		526.0
500A	20"	508.0	508.0	508.0	508.0	521.0	532.0			508.0		584.0

**KS** : Korean Industrial Standards  
**JIS** : Japan Industrial Standards  
**ASTM** : American Society for Testing Materials  
**ANSI** : American National Standards Institute  
**ISO** : International Organization For Standardization  
**DIN** : Deutsches Institut fur Normung  
**BS** : British standards  
**GRP PIPE** : Glass-Fiber Reinforcement Plastic

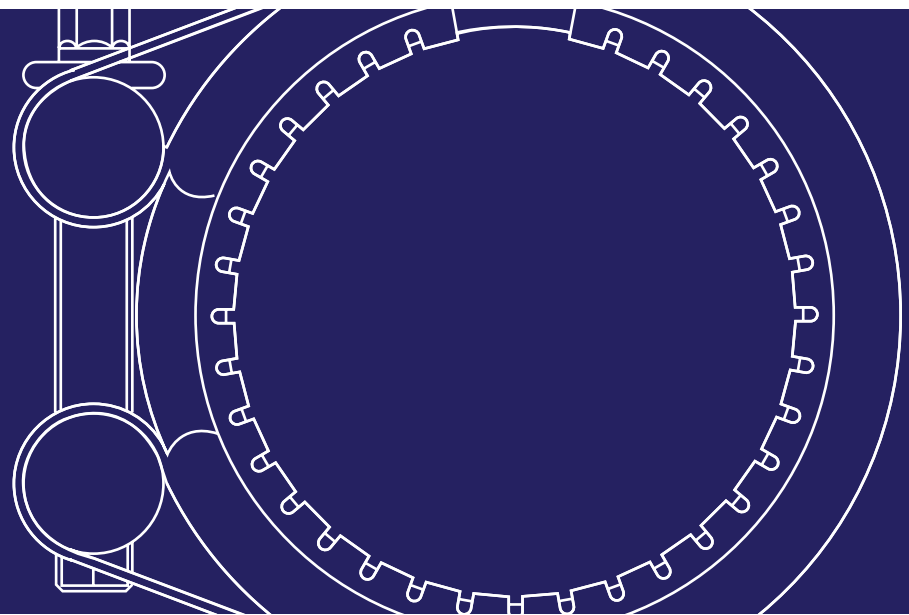

**YOUNGNAM METAL CO., LTD**  
**YN-COUPPLINGS**

12-3 Jillye-ro 74beon-gil, Jillye-myeon

Gimhae-si, Gyeongsangnam-do, 50874 Korea

TEL.+ 82-55-345-3195 FAX.+ 82-55-345-3198

E-mail : [info@yncoupling.com](mailto:info@yncoupling.com) / [kimsta@yncoupling.com](mailto:kimsta@yncoupling.com)

[www.yncoupling.com](http://www.yncoupling.com)

 Facebook : <https://www.facebook.com/yncoupling>

 Instagram : <https://www.instagram.com/pipecouplings>